

amop®
synergies



HOUSE & GARDEN

COVERINGS

YARDS AND POOLS

OUTDOOR FURNITURE

CASA & JARDIM

REVESTIMENTOS

PÁTIOS E PISCINAS

MOBILIÁRIO DE EXTERIOR

TOSCO

TOSCO

PRIVATE



RECTUS AMARELO PRAM6T
RECTUS YELLOW
≈ 20x10x6 cm 132Kg/m²



RECTUS PRETO PRPT6T
RECTUS BLACK
≈ 20x10x6 cm 132Kg/m²



RECTUS BRANCO PRBR6T
RECTUS WHITE
≈ 20x10x6 cm 132Kg/m²

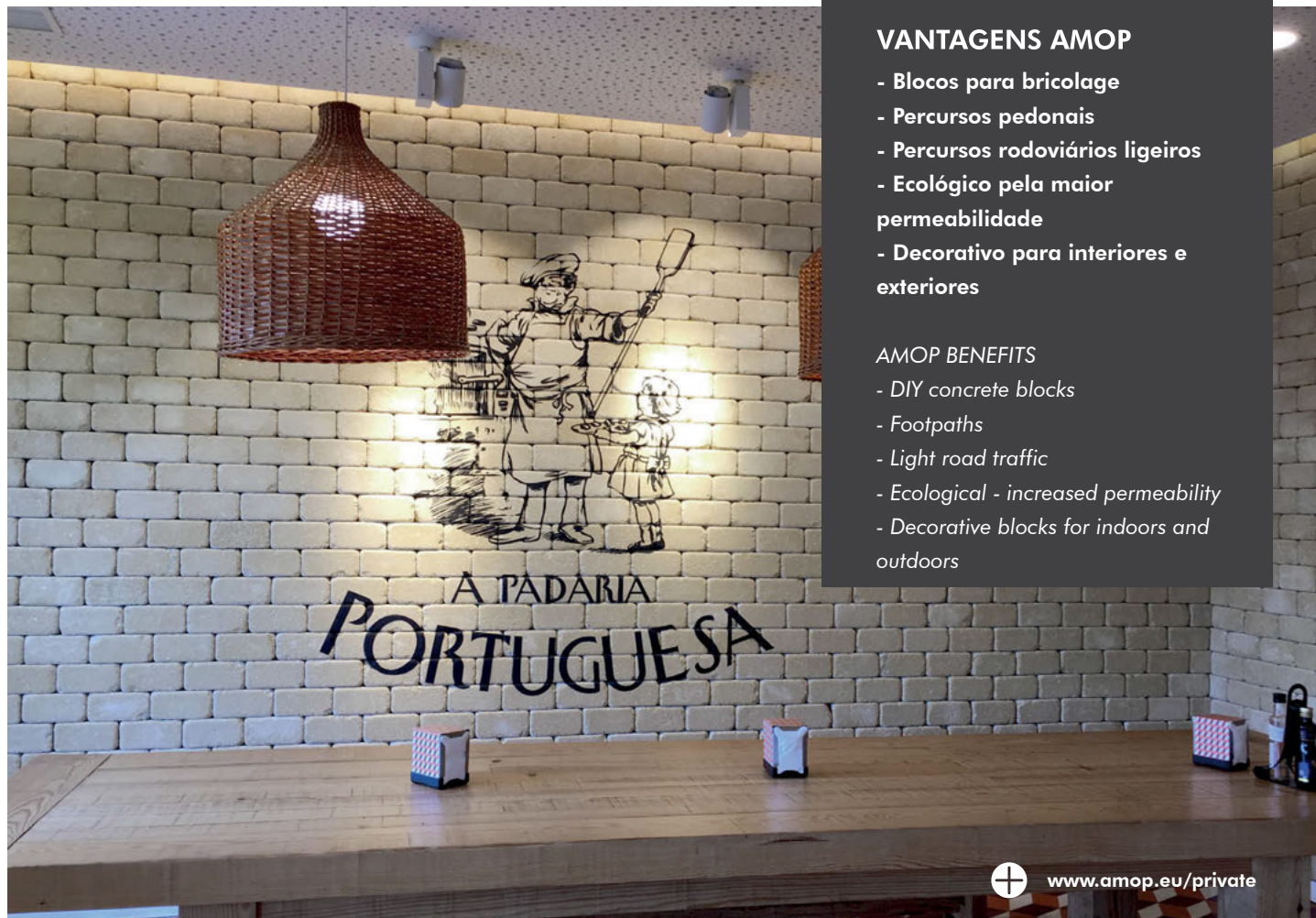

VANTAGENS AMOP

- Blocos para bricolage
- Percursos pedonais
- Percursos rodoviários ligeiros
- Ecológico pela maior permeabilidade
- Decorativo para interiores e exteriores

AMOP BENEFITS

- DIY concrete blocks
- Footpaths
- Light road traffic
- Ecological - increased permeability
- Decorative blocks for indoors and outdoors



www.amop.eu/private

PAS JAPONAIS

PRIVATE

PAS JAPONAIS



PAS JAPONAIS BRANCO
WHITE 1802000010101
≈ 40x51x3cm 12Kg/un



PAS JAPONAIS PRETO
BLACK 1802000010201
≈ 40x51x3cm 12Kg/un



PAS JAPONAIS CINZA
GREY 1802000010701
≈ 40x51x3cm 12Kg/un



PAS JAPONAIS CREME
CREAM 1802000011001
≈ 40x51x3cm 12Kg/un



PAS JAPONAIS AMARELO
YELLOW 1802000011101
≈ 40x51x3cm 12Kg/un



PAS JAPONAIS CASTANHO
BROWN 1802000010301
≈ 40x51x3cm 12Kg/un



PEDRAS DECORATIVAS

DECORATIVE STONES

PRIVATE



MÁRMORE BRANCO ROLADO AG0101001

ROLLED WHITE MARBLE

2/4 , 3/6 , 6/10 cm



BASALTO ROLADO AG0301000

ROLLED BASALT

2/4 , 3/6 , 6/10 cm



GRAVILHA XISTO PRETO AG1506013

GRAVEL SHALE BLACK

2/4 , 3/6 cm



SEIXO AG0600000

RIVER STONE

2/4 , 3/6 cm



Bulk
>1500Kg



Big-Bag
>1000Kg



Slim-Bag
350Kg



25Kg

VANTAGENS AMOP

- Percursos pedonais
- Proteção das plantas
- Decoração do Jardim
- Elegância
- Solução económica
- Durabilidade
- Sem manutenção

AMOP BENEFITS

- Footpaths
- Protection of plants
- Garden Decoration
- Elegance
- Economic solution
- Durability
- No maintenance



www.amop.eu/private

CONCRETE DECK

CONCRETE DECK

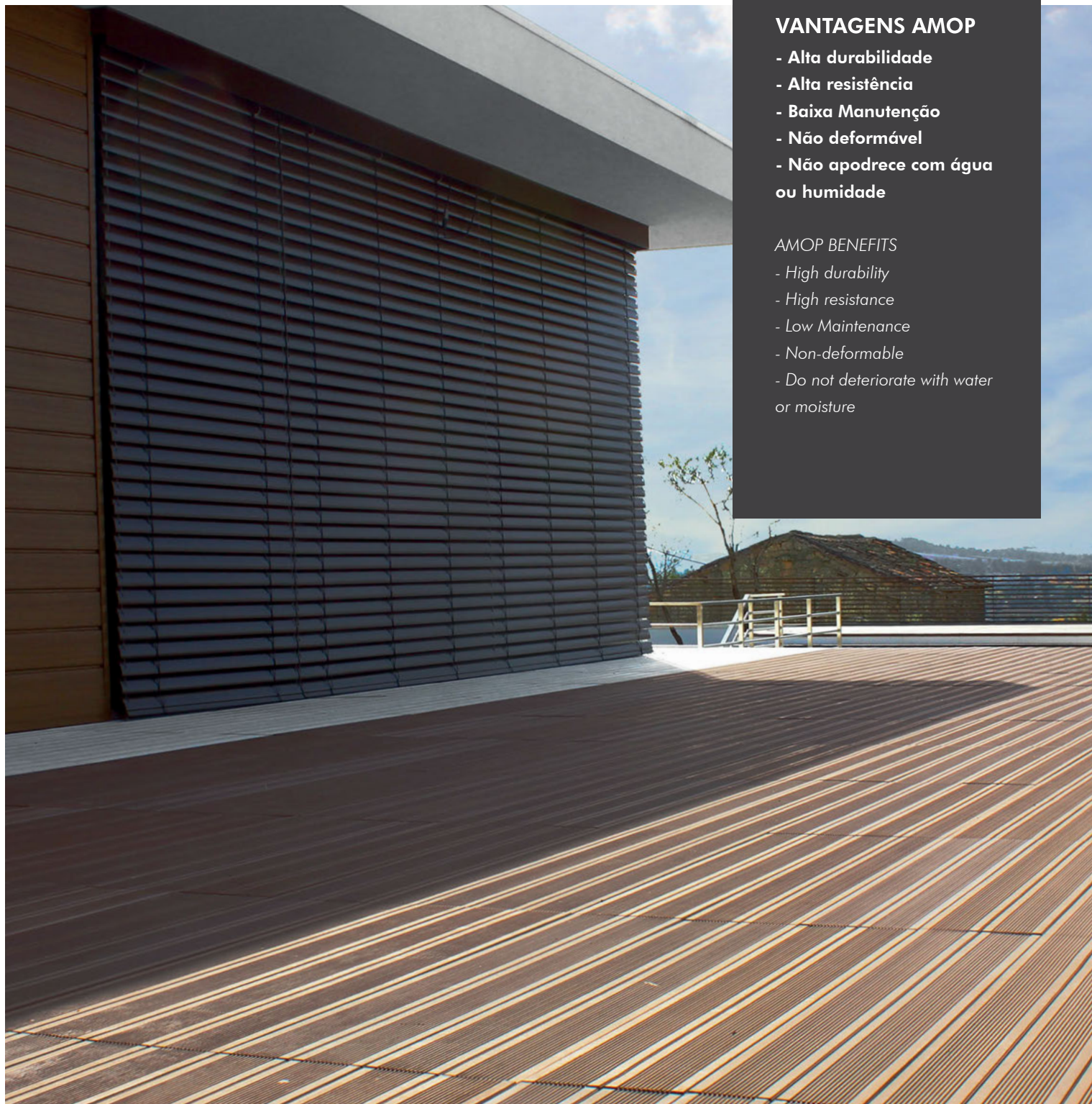

VANTAGENS AMOP

- Alta durabilidade
- Alta resistência
- Baixa Manutenção
- Não deformável
- Não apodrece com água ou humidade

AMOP BENEFITS

- High durability
- High resistance
- Low Maintenance
- Non-deformable
- Do not deteriorate with water or moisture

PEÇA DECK

DECK PIECE

≈ 100x20x4,5 cm

≈ 98,25 Kg/m²





DECK BRANCO 1802100010101
WHITE DECK



DECK PRETO 1802100010201
BLACK DECK



DECK CASTANHO 1802100010301
BROWN DECK



DECK CINZA 1802100010701
GREY DECK



DECK AMARELO 1802100011101
YELLOW DECK



DECK CREME 1802100011001
CREAM DECK

BORDADURA DECK

DECK BORDER
≈ 100x30x4,5 cm
≈ 29,45 Kg/ml



NODE

NODE



VANTAGENS AMOP

- Alta durabilidade
- Alta resistência
- Baixa Manutenção
- Não deformável
- Não apodrece com água ou humidade
- Textura da Madeira

AMOP BENEFITS

- High durability
- High resistance
- Low Maintenance
- Non-deformable
- Do not deteriorate with water or moisture
- Wood Texture



NODE 27000010
90x15x4cm ≈ 88Kg/m²



NODE 27001010
90x30x4cm ≈ 88Kg/m²

Cores disponíveis:
Available in different colours:



MEGA LAJETAS

MEGA PAVING FLAG

PRIVATE

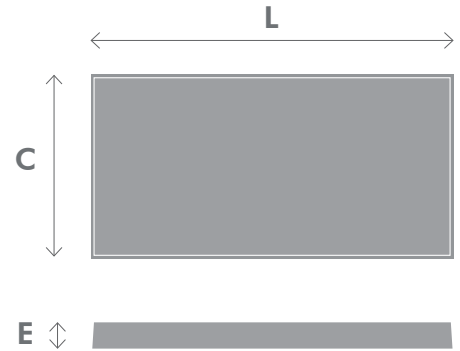

MEGA LAJETA
MEGA-PAVING FLAG
≈ 150Kg/m²

Disponível em vários acabamentos:
Available in different finishes:

Betão CS Liso
Cast Stone Smooth



Betão CS Bujardado
Cast Stone Sandblasted



REF	L cm	C cm	E cm
12001	50	50	6
12002	100	25	6
12003	100	50	6
12004	120	80	6
12005	100	100	6
12019	140	70	6
12006	140	100	6

Outras medidas disponíveis por encomenda.
Other measures available by request.



VANTAGENS AMOP

- Alta durabilidade
- Alta resistência
- Baixa Manutenção
- Não deformável
- Não apodrece com água ou humidade

AMOP BENEFITS

- High durability
- High resistance
- Low Maintenance
- Non-deformable
- Do not deteriorate with water or moisture

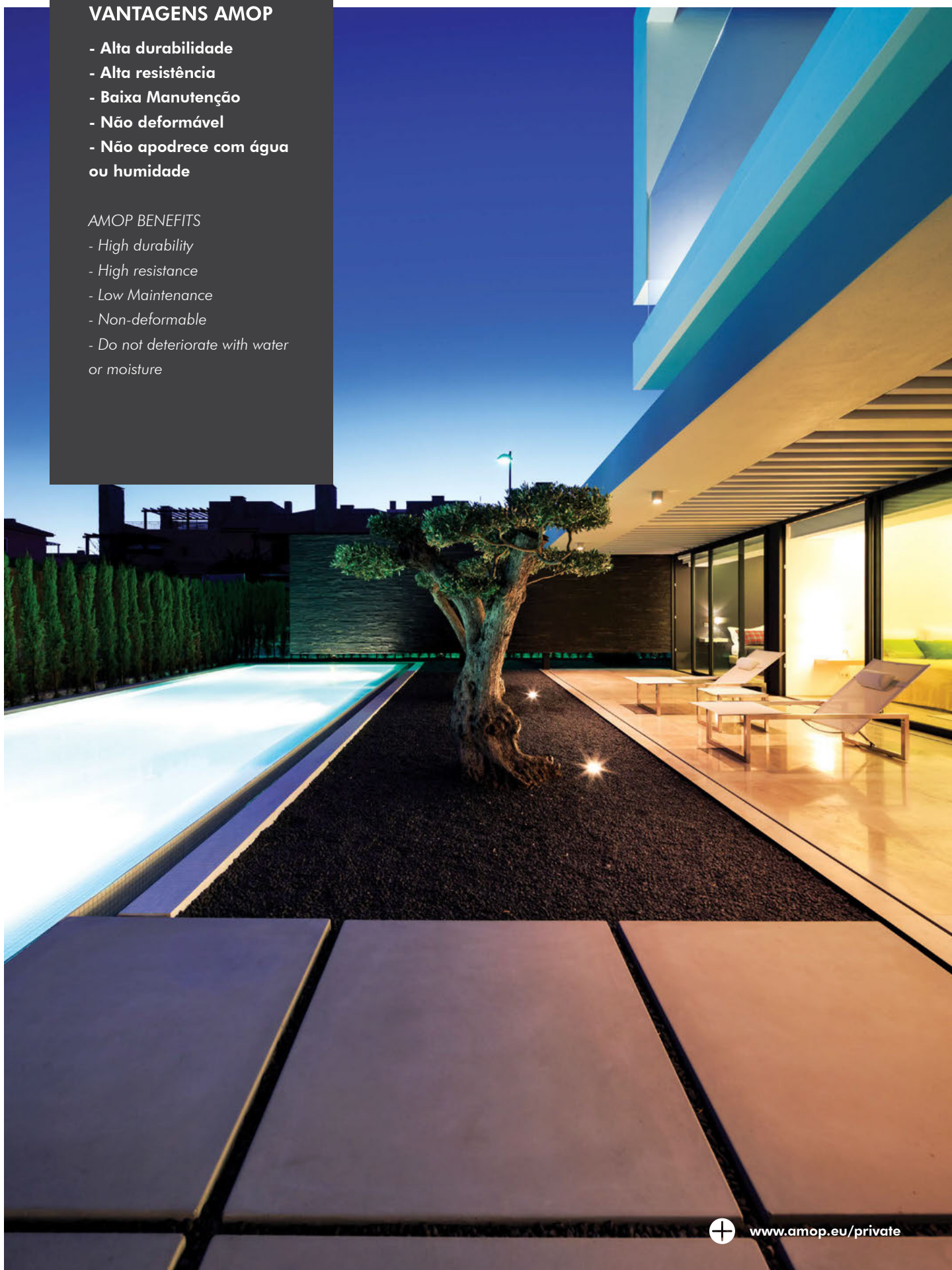

CONCRETE LIVING

CONCRETE LIVING

Churrasqueira, armazenagem de lenha, bancos, mesas de apoio e floreiras, para compor um espaço de lazer, prático e confortável, com um design neutro e contemporâneo, à medida do seu pátio ou jardim.

Barbecue, wood storage, benches, tables and planters, to create a practical and comfortable leisure space, with a neutral and contemporary design, customized for your yard or garden.



CHURRASQUEIRA 9 14054
BARBECUE 9
140x187x70cm ≈ 550Kg



CHURRASQUEIRA 8 14053
BARBECUE 8
140x130x70cm ≈ 325Kg
Grelhador não incluído. Adquirido separadamente.
Grill not included. Bought separately.



CHURRASQUEIRA 7
BARBECUE 7
14047
80x130x45cm ≈ 325Kg



CHURRASQUEIRA 6
BARBECUE 6
14046
80x187x45cm ≈ 500Kg



CHURRASQUEIRA 3
BARBECUE 3
14003
80x227x45cm ≈ 535Kg



CHURRASQUEIRA 8
BARBECUE 8
14053
140x130x70cm ≈ 325Kg



CHURRASQUEIRA 9
BARBECUE 9
14054
140x187x70cm ≈ 550Kg

VANTAGENS AMOP

- Durabilidade e Estabilidade
- Linhas modernas
- Fácil conjugação com outros materiais
- Baixa absorção de água
- Acabamento em betão ou pedra aparente

AMOP BENEFITS

- Durability
- Stability
- Modern lines
- Easily combined with other materials
- Low water abstraction
- Concrete or stone surface finish



Materiais e Acabamentos:
Materials and finishes:

Betão CS Liso
Cast Stone Smooth



400 BR 400 CZ

Betão CS Bujardado
Cast Stone Sandblasted

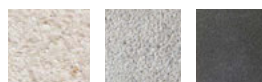

475 445 425

Chapa Forjada Preta
Forged Black Metal



MESAS APOIO E BANCOS TABLES AND BENCHES



MÓDULO CK3 14032
MODULE CK3
40x40x40cm ≈ 55Kg

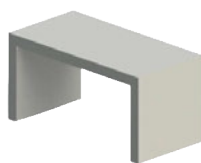

MÓDULO CK1 14030
MODULE CK1
80x40x40cm ≈ 75Kg



MÓDULO CK4 14033
MODULE
80x17x40cm ≈ 50Kg

FLOEIRAS PLANTERS



FLOEIRA 14055
PLANTER
80x40x40cm ≈ 78Kg



FLOEIRA 14056
PLANTER
40x40x40cm ≈ 57Kg



FRAME

PRIVATE

FRAME



CADEIRA FRAME 29001
FRAME CHAIR
80x80x60cm ≈ 25Kg



MESA DE APOIO FRAME 29002
FRAME SIDE TABLE
45x45x45cm ≈ 17Kg



BANCO FRAME 29003
FRAME BENCH
45x45x45cm ≈ 15Kg

Metal Lacado
Lacquered Metal



FLOW

PRIVATE

FLOW



LOUNGE 26002

LOUNGE

91x88x65cm Base / Base ≈ 80Kg + Assento / Seat ≈ 50Kg



CHAISE 26001

CHAISE

180x56x65cm Base / Base ≈ 85Kg + Assento / Seat ≈ 75Kg



MESA LOUNGE 26003

LOUNGE TABLE

80x37,5x31cm ≈ 25 Kg



MESA CHAISE 26004

CHAISE TABLE

74x17x31cm ≈ 20 Kg



CONCRETE WOOD

CONCRETE WOOD

VANTAGENS AMOP

- Alta Durabilidade
- Peso/Elevada Estabilidade
- Baixa Manutenção
- Neutro, fácil conjugação com mobiliário diverso

AMOP BENEFITS

- High Durability
- Weight / High Stability
- Low Maintenance
- Neutral, easy to combine with other furniture pieces



MESA CONCRETE WOOD

3000114011512

CONCRETE WOOD TABLE

Diam. 140x75cm 6 a 8 pessoas
6 to 8 people

Tampo UHPC
Table Top UHPC



Base Pinho Theermowood
Base Thermowood Pine



ROUND UP

ROUND UP

PRIVATE



MESA ROUND UP

2800313011512

ROUND UP TABLE

Diam. 140x75cm 6 a 8 pessoas
6 to 8 people



MESA APOIO ROUND UP

2800513011512

ROUND UP SIDE TABLE

Diam. 80x45cm



MESA BAR ROUND UP

2800113011612

ROUND UP BAR TABLE

Diam. 80x110cm

Tamos UHPC
Table Tops UHPC



Base: Metal Lacado
Base: Lacquered Metal



HEXA, CRISTAL e SHAVINGS

HEXA, CRISTAL AND SHAVINGS

ORGANII

Bio Yourself.



Revestimento de paredes em Betão UHPC com volumetria e escala que acrescentam valor estético e carácter às superfícies de espaços interiores.

UHPC Concrete Wall Covering, with volumetry and scale, which add aesthetic value and character to the surfaces of indoor spaces.

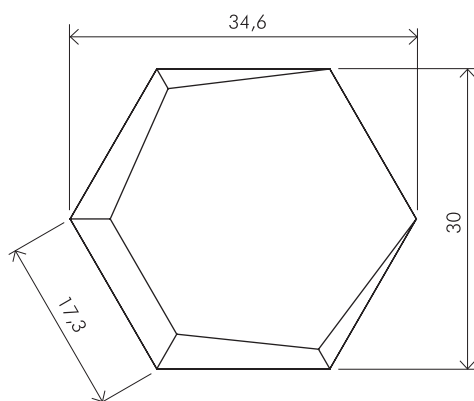

HEXA BRANCO 2700800011602
HEXA WHITE
34,6x30x2,3cm ≈ 2,7 Kg



HEXA CINZA 2700800011502
HEXA GREY
34,6x30x2,3cm ≈ 2,7 Kg

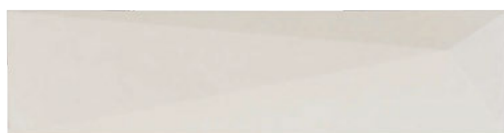
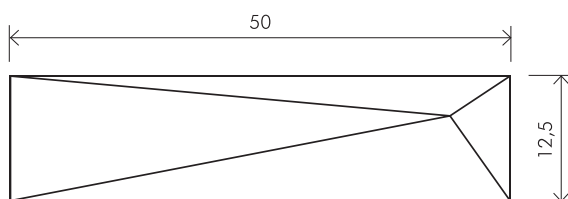

CRISTAL BRANCO 2700500011602
CRISTAL WHITE
50x12,5x2,3cm ≈ 2 Kg



CRISTAL CINZA 2700500011502
CRISTAL GREY
50x12,5x2,3cm ≈ 2 Kg

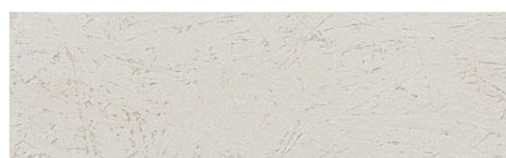

SHAVINGS
SHAVINGS WHITE
50x15x1,5cm ≈ 3 Kg Ref. 2700700011602
100x15x1,5cm ≈ 6 Kg Ref. 2700600011602

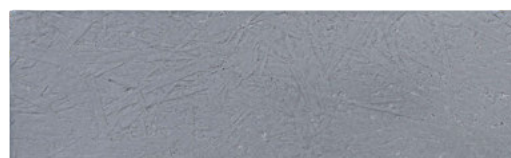

SHAVINGS
SHAVINGS GREY
50x15x1,5cm ≈ 3 Kg Ref. 2700700011502
100x15x1,5cm ≈ 6 Kg Ref. 2700600011502



AMOP, Lda
R. Chão Redondo, 258
Apt. 38
3754-906 Aguada de Baixo
Águeda - Portugal

T. 234 667 957
F. 234 666 908
E. amop@grupoamop.com

www.grupoamop.com

GPS
N 40 30.837, W 8 26.465

Export Contacts
T. +351 234 661 904
F. +351 234 661 903
E. export@grupoamop.com



SCAN QR CODE

